

Model: TRP795L42

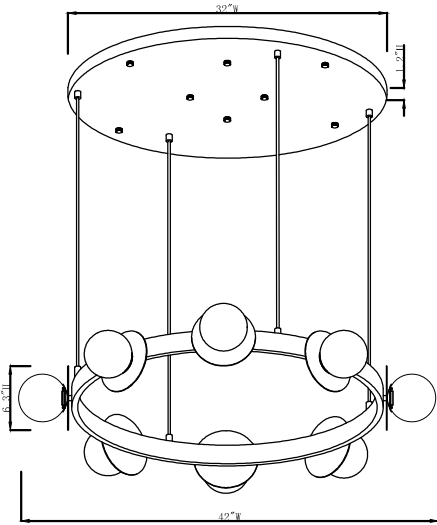

Parts package

Item	Name	Qty
	Mounting screw	2
	Wire connector	3
	Expansion plug	8
	Self tapping screw	8
	Explosive screws	12

Tools required: Flathead screwdriver, Phillips screwdriver, pliers, wire cutters, wire strippers, electrical tape, safety glasses.

Preparation: Identify and inspect all parts before beginning installation. Check package content list to be sure all parts are present. If any parts are missing or damaged, do not attempt to assemble, install, or operate the fixture. Contact customer service for replacement parts.

Warnings and Cautions

Please Note : Due to the weight of this fixture, it must be mounted independently from the junction box. Additional means of support is required.

Have your fixture installed by a qualified, licensed electrician.

Turn off electricity at circuit breaker or main fuse box before installation. Consult a licensed electrician if in doubt.

Disconnect fixture from power source before replacing bulbs.

Make sure bulbs are given sufficient time to cool before removal.

Do not subject glass parts to any shock while in operation or shattering may result.



TRUE LIGHT CO.

Installation

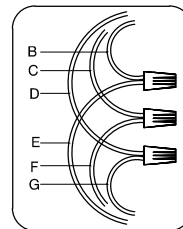
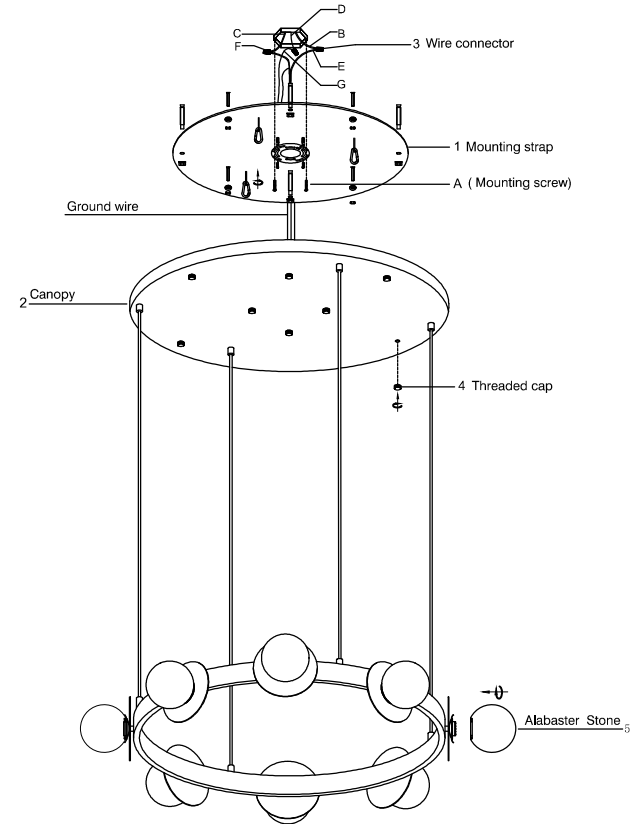

A-Mounting screws x 2 (provided)
 B-Black wire (L) from junction box
 C-White wire (N) from junction box
 D-Green wire/bare copper (G) from junction box
 E-Black wire from fixture
 F-White wire from fixture
 G-Bare wire from fixture

Installation Instructions:

1. Thread the eye bolt on to the nipple of the fixture and tighten.
2. Attach the mounting strap to the junction box using the 2 provided screws (A).
3. Make electrical connections with the house wires to the fixture wires. Refer to the wiring chart and follow instructions. Tuck the wires neatly to the ceiling junction.
4. Install the threaded cap.
5. Install the alabaster stone.